

fb ferbox

ORIGAMI

bathroom collection

BY FERBOX



ere.

CONCEPT and DESIGN

Esattamente come un foglio di carta che non ha ancora nessuna forma, contiene già in sé tutte le pieghe necessarie alla realizzazione di un origami.

Exactly like a sheet of paper that does not yet have any shape, it already contains in itself all the folds necessary for the realization of an origami.

Dopo la Laurea in Ingegneria Edile Architettura, inizia il percorso di formazione presso un noto Studio di Architettura. Un'esperienza decennale che affinerà il gusto minimalista ed una conoscenza tecnica già noti, unendoli ad una passione per i dettagli, che la porterà a fondare il proprio studio.

«La progettazione parte dall'idea senza mai prescindere dalla sua realizzabilità, senza che quest'ultimo aspetto possa limitarla. Il progetto di architettura diviene strumento ordinatore di un articolato processo di trasformazione della materia e degli spazi.

After graduating in Architectural Building Engineering, she began the training course at a well-known Architecture Studio. A ten-year experience that will refine the minimalist taste and a technical knowledge already known, uniting them to a passion for details, which has convinced her to found her own Studio.

«The design starts from the idea without ever leaving aside its feasibility, without this last aspect limiting it. The architectural project becomes an authorizing tool for a complex process of transformation of matter and spaces

Design by Ing. Elisa Romagnoli

INDICE | INDEX

SNAKE_4

CUBE_10

BRIDGE_20

LISTINO COMPOSIZIONI | LAYOUT PHOTOS PRICELIST_27

LISTINO MODULI | MODULES PRICELIST_30

BOX DOCCIA | SHOWER ENCLOSURE_43

SNAKE

composizione _1
L.122 P.45 cm
SX



Telaio nero | black frame
Lavabo integrato | integrated washbasin
Ripiano e Fianchi in Ocritech | Ocritech shelf and lateral sides





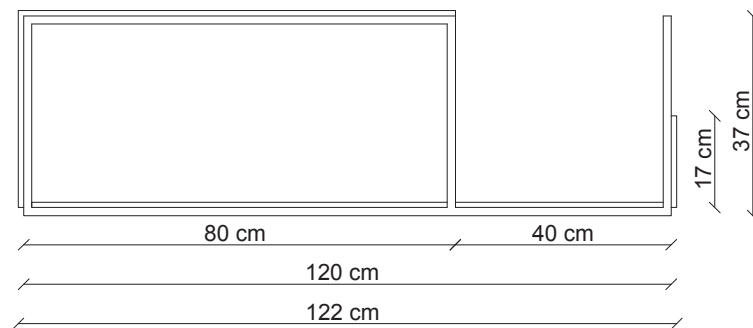

SNAKE

Info tecniche

Dimensioni

L.122 P.45 cm

Top

Ocritech bianco opaco
con vasca integrata sx

Telaio



Nero opaco soft touch

SNAKE

composizione _2
L.122 P.45 cm
SX

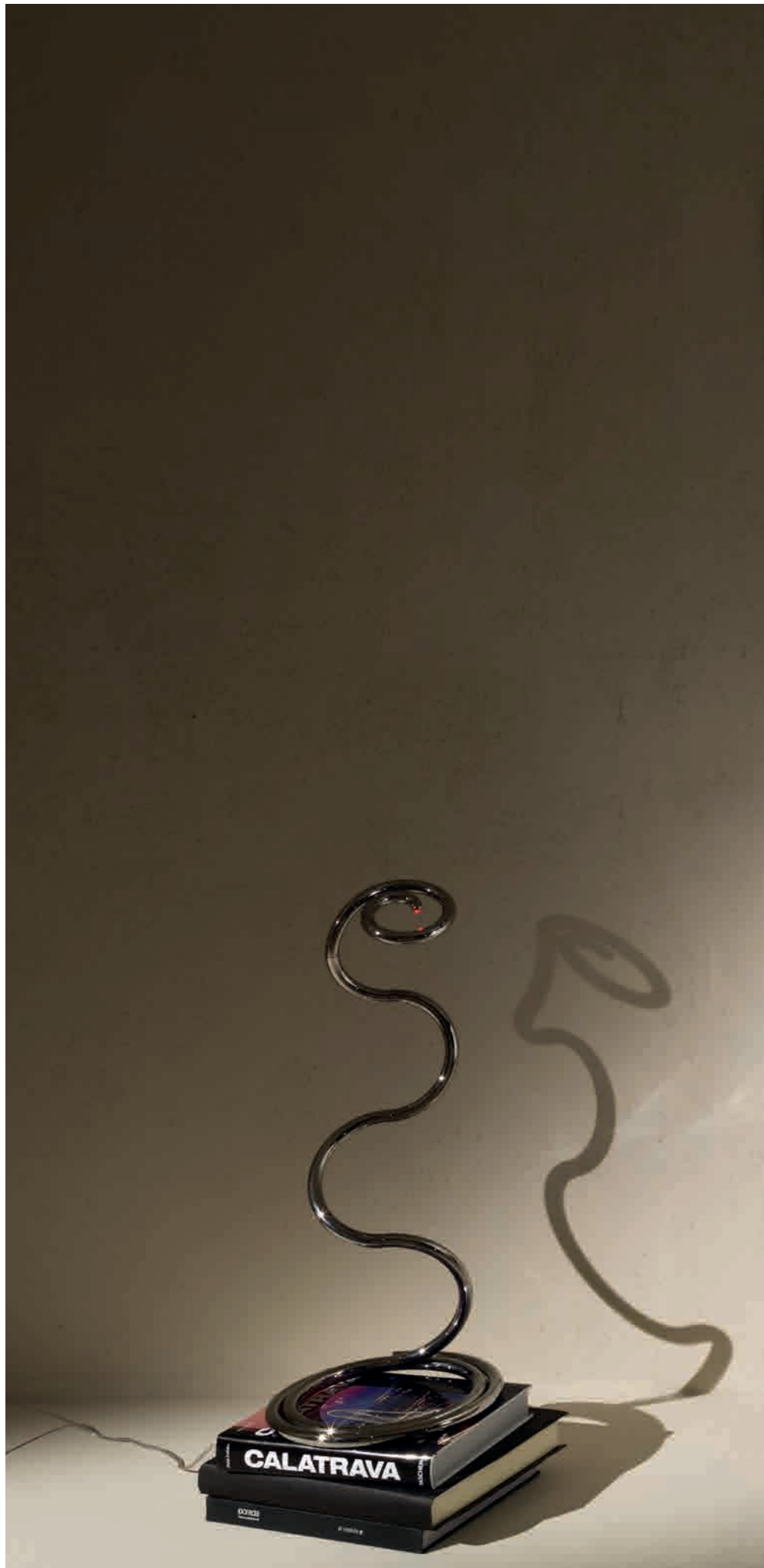

Telaio nero | black frame
Ciotola in appoggio | countertop washbasin
Ripiano e Fianchi in Ocrittech | Ocrittech shelf and lateral sides



CUBE

composizione _3
L.90 P.45 cm
sottopiano hole dx



Telaio grigio | grey frame
Ciotola in appoggio | countertop washbasin
Sottopiano con porta salviette | Top with lateral towel hanger
Ripiano inferiore Origami | Bottom shelf Origami





CUBE

Info tecniche

Dimensioni

L.90 P.45 cm

Top

Ocritech bianco opaco
con porta salviette dx

Lavabo

Ciotola in appoggio SLIM
in ocritech bianco opaco

Telaio



Grigio opaco soft touch

Ripiano

Piano di appoggio inferiore in alluminio ORIGAMI

Top Hole

top hole_90

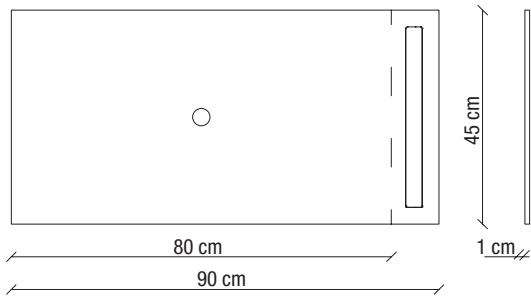

prospetto superiore

Blocks

cube_80

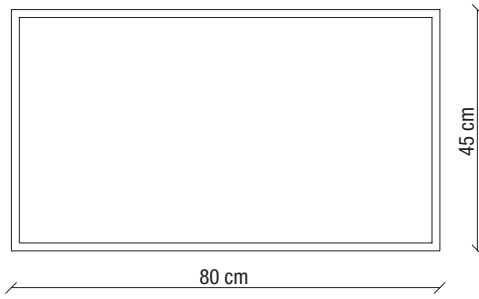

prospetto frontale

top hole_100

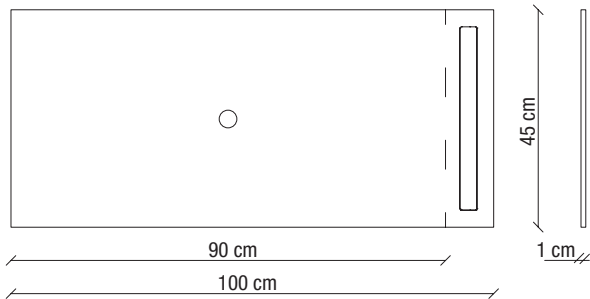

prospetto superiore

cube_90

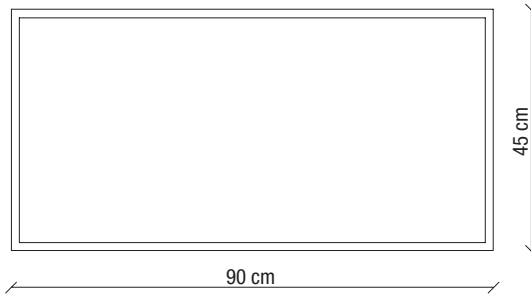

prospetto frontale

top hole_110

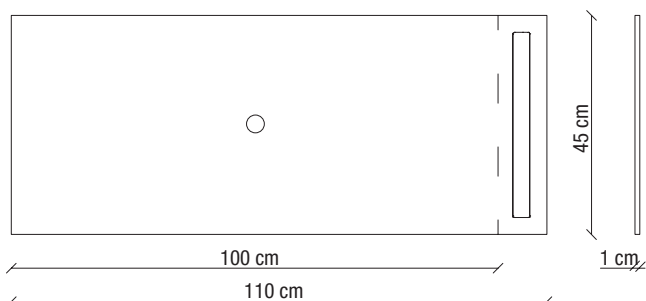

prospetto superiore

cube_100

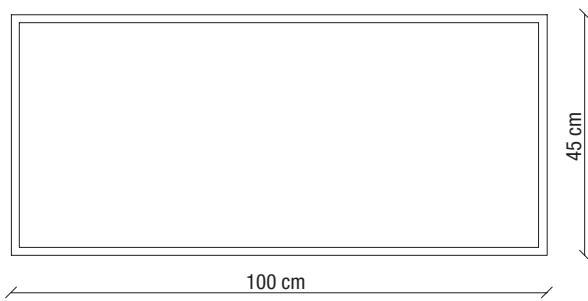

prospetto frontale

CUBE

composizione _4
L.80 P.45



CUBE

composizione _5
L.80 P.45



CUBE



Telaio nero | black frame

Top con ciotola in appoggio | top with countertop washbasin

Ripiano e alzatina in alluminio Origami | aluminum shelf and backslash Origami

CUBE



white frame | Telaio bianco
top with countertop washbasin | Top con ciotola in appoggio
aluminum shelf and backslash Origami | Ripiano e alzatina in alluminio Origami

CUBE

composizione _6
L.80 P.45
Top scatolato H.12



Telaio nero | black frame
Top lavabo scatolato Ocritech | Ocritech Top with Integrated washbasin
Ripiano inferiore Ocritech | Ocritech bottom shelf



BRIDGE

composizione _7
L.90 P.45
Top scatolato H.12



Telaio rosa | pink frame
Top lavabo scatolato Ocritech | Ocritech Top with Integrated washbasin
Ripiano inferiore Ocritech | Ocritech bottom shelf





BRIDGE

Info tecniche

Dimensioni

L.90 P.45 cm

Top

Scatolato con vasca integrata
in Ocritech bianco opaco

Specchiera

Ø 100cm

Telaio



Rosa opaco soft touch

Ripiano

Piano di appoggio inferiore in Ocritech bianco opaco

Top Hole

top scatolato_80

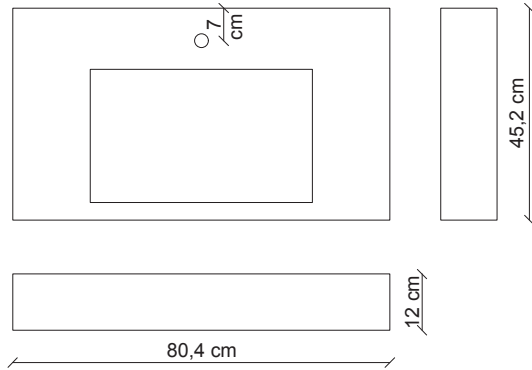

Blocks

bridge_80

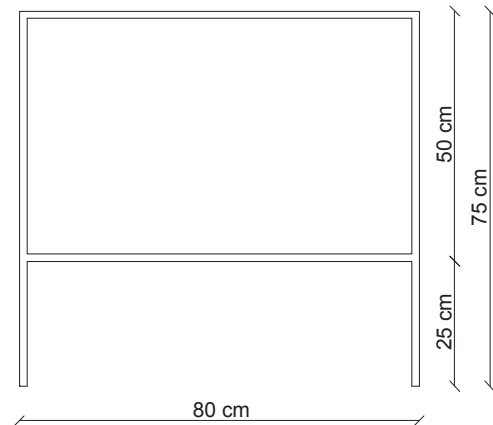

prospetto frontale

top scatolato_90

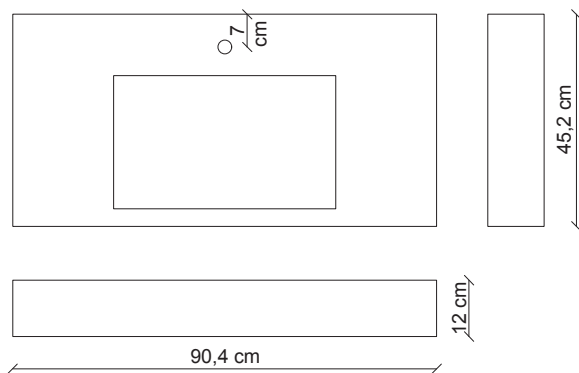

bridge_90

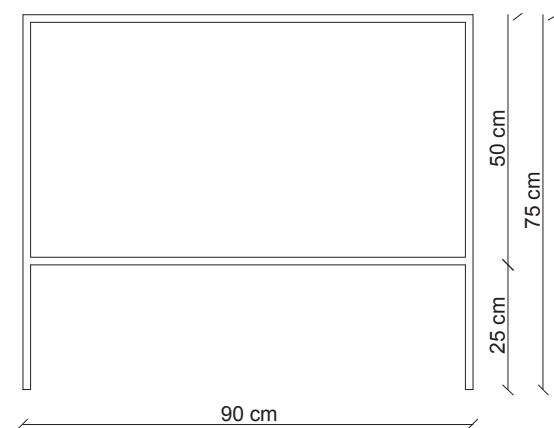

prospetto frontale

top scatolato_100

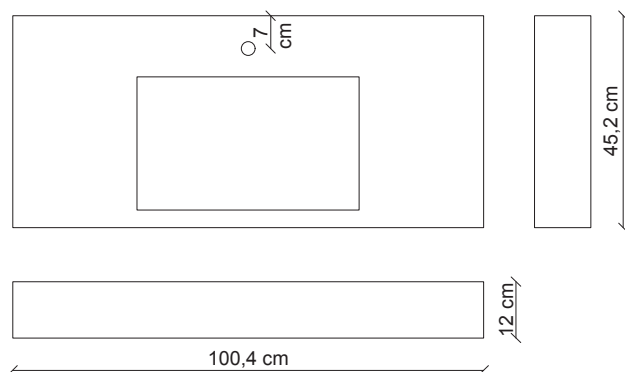

bridge_100

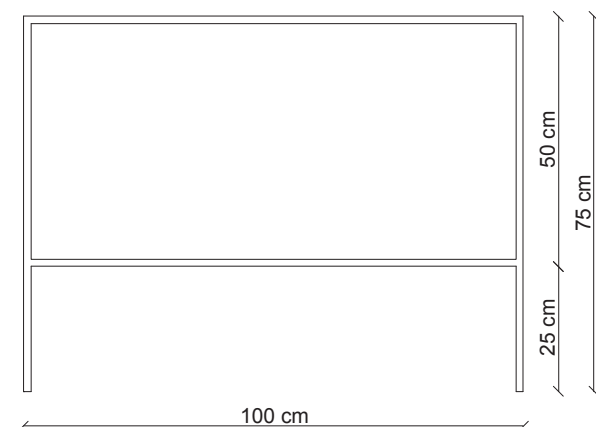

prospetto frontale

BRIDGE

composizione _8
L.90 P.45



Telaio nero | black frame

Ciotola in appoggio bi-color | bi-color countertop washbasin

Top sotto ciotola in Ocritech | Ocritech top under counter top washbasin

Ripiano inferiore Ocritech | Ocritech bottom shelf



BOX DOCCIA
SHOWER ENCLOSURE

INDUSTRIAL COLLECTION

Modello Walk-in PA1 Trasparente

Descrizione

Parete doccia fissa con cristallo temperato sp.6mm. Profili in alluminio nero opaco, regolazione profilo a muro 2cm, profilo inferiore.

Fermavetro sempre incluso.

Description

Shower wall with 6mm safety glass and aluminum profiles. 2cms regulation of the wall profile and lower aluminum profile under the glass. Fixing bar always included.

ART.	L. (cm)	H. (cm)	Cristallo Glass	Profilo Profiles
PA1 50 *	48/50	200	6mm trasparente	nero opaco
PA1 60 *	58/60	200	6mm trasparente	nero opaco
PA1 70 *	68/70	200	6mm trasparente	nero opaco
PA1 80 *	78/80	200	6mm trasparente	nero opaco
PA1 90 *	88/90	200	6mm trasparente	nero opaco
PA1 100 *	98/100	200	6mm trasparente	nero opaco
PA1 120 *	118/120	200	6mm trasparente	nero opaco
PA1 140 *	138/140	200	6mm trasparente	nero opaco
PA1 160 *	158/160	200	6mm trasparente	nero opaco

* Fermavetro retto 100cm incluso | straight 100cms fixing bar included

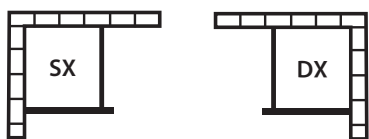

Versi di istallazione | installation sense

PA1

Info tecniche

Alluminio

Profilo a muro (mm)

Wall profile



Nero opaco

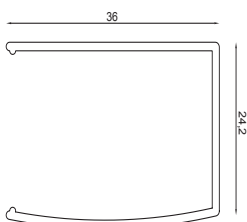



INDUSTRIAL COLLECTION

Modello Walk-in **PA1_SerigrafiaOrizzontale**

Descrizione

Parete doccia fissa con cristallo temperato sp.6mm con serigrafia righe orizzontali sp.1,7cm. Profili in alluminio nero opaco, regolazione profilo a muro 2cm, cornice in alluminio con taglio a 45°. Fermavetro sempre incluso.

Description

Shower wall with 6mm safety glass and aluminum profiles with horizontal serigraphy lines thick 1,7cm. 2cms regulation of the wall profile and frame in aluminum with 45° cut. Fixing bar always included.

ART.	L. (cm)	H. (cm)	Cristallo Glass	Profilo Profiles
PA1 70 *	68/70	200	6mm serigrafia_SO	nero opaco
PA1 80 *	78/80	200	6mm serigrafia_SO	nero opaco
PA1 90 *	88/90	200	6mm serigrafia_SO	nero opaco
PA1 100 *	98/100	200	6mm serigrafia_SO	nero opaco
PA1 120 *	118/120	200	6mm serigrafia_SO	nero opaco
PA1 140 *	138/140	200	6mm serigrafia_SO	nero opaco

* **Fermavetro retto 100cm incluso** | straight 100cms fixing bar included

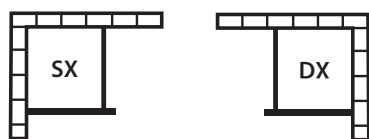

Versi di istallazione | installation sense

PA1

Info tecniche

Alluminio

Profilo a muro (mm)

Wall profile



Nero opaco

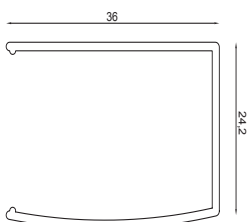



INDUSTRIAL COLLECTION

Modello Walk-in **PA1_SerigrafiaVerticale**

Descrizione

Parete doccia fissa con cristallo temperato sp.6mm con serigrafia geometrica verticale sp.1cm. Profili in alluminio nero opaco, regolazione profilo a muro 2cm, profilo inferiore. Fermavetro sempre incluso.

Description

Shower wall with 6mm safety glass and aluminum profiles with geometric vertical lines thick 1cm. 2cms regulation of the wall profile lower profile under the glass. Fixing bar always included.

ART.	L. (cm)	H. (cm)	Cristallo Glass	Profilo Profiles
PA1 100 *	98/100	200	6mm serigrafia_SV	nero opaco
PA1 120 *	118/120	200	6mm serigrafia_SV	nero opaco

* **Fermavetro retto 100cm incluso** | straight 100cms fixing bar included

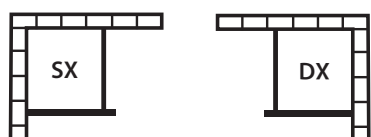

Versi di istallazione | installation sense

PA1

Info tecniche

Alluminio

Profilo a muro (mm)

Wall profile



Nero opaco

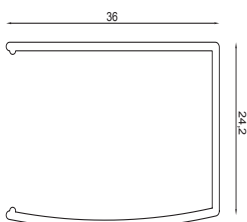



INOX REVOLUTION

Box Doccia Scorrevole **QUBO DOOR_QUBO FIX**

Descrizione

Porta doccia scorrevole per installazione tra due muri o con laterale fisso. Cristalli temperati sp.8mm e profili in acciaio inox. Regolazione dei profili a muro 2cm.

Description

Sliding shower door for single installation between two walls, or to combine with a lateral fix side. 8mm safety glass and stainless steel profiles. 2cms wall regulation profiles.

ART.	L. (cm)	H. (cm)	Cristallo Glass	Profilo Profiles
QUBO DOOR*	117/119	195	8mm trasparente	inox brill
QUBO DOOR*	127/129	195	8mm trasparente	inox brill
QUBO DOOR*	137/139	195	8mm trasparente	inox brill
QUBO DOOR*	147/149	195	8mm trasparente	inox brill
QUBO DOOR*	157/159	195	8mm trasparente	inox brill

* Porta singola per installazione tra 2 muri | Single sliding door to install between 2 walls

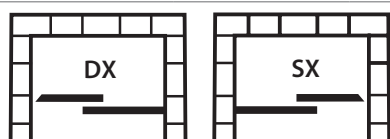

ART.	L. (cm)	H. (cm)	Cristallo Glass	Profilo Profiles
QUBO DOOR*	117/119	195	8mm trasparente	inox brill
QUBO DOOR*	127/129	195	8mm trasparente	inox brill
QUBO DOOR*	137/139	195	8mm trasparente	inox brill
QUBO DOOR*	147/149	195	8mm trasparente	inox brill
QUBO DOOR*	157/159	195	8mm trasparente	inox brill

* Porta singola per installazione con lato fisso | Single sliding door to install with a fix lateral side

ART.	L. (cm)	H. (cm)	Cristallo Glass	Profilo Profiles
QUBO FIX	67/69	195	8mm trasparente	inox brill
QUBO FIX	77/79	195	8mm trasparente	inox brill
QUBO FIX	87/89	195	8mm trasparente	inox brill



QUBO DOOR_FIX

Info tecniche

Profilo a muro (mm)

Wall profile

Profili



Inox brill

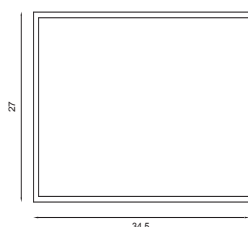



INOX REVOLUTION

Box Doccia Scorrevole **QUBO**

Descrizione

Box doccia scorrevole con ingresso in angolo. Cristalli temperati sp.8mm e profili in acciaio inox. Regolazione dei profili a muro 2cm.

Description

Corner sliding shower enclosure . 8mm safety glass and stainless steel profiles. 2cms wall regulation profiles.

ART.	L. (cm)	H. (cm)	Cristallo Glass	Profilo Profiles
QUBO 80x80	77/79	195	8mm trasparente	inox brill
QUBO 90x90	87/89	195	8mm trasparente	inox brill
QUBO 100x100	97/98	195	8mm trasparente	inox brill
QUBO 70x100	67/69 - 97/99	195	8mm trasparente	inox brill
QUBO 80x100	77/79 - 97/99	195	8mm trasparente	inox brill

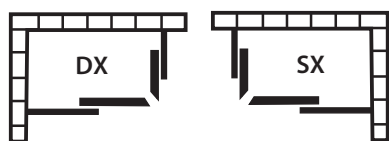

Versi di installazione | installation sense

QUBO DOOR_FIX

Info tecniche

Profili

Profilo a muro (mm)

Wall profile



Inox brill

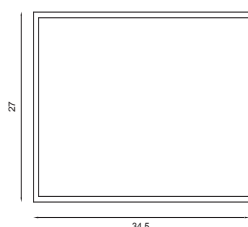



春



SANDERRA COLLECTION

Box Doccia Scorrevole **SANDERRA DOOR_FIX**

Descrizione

Porta doccia scorrevole per installazione tra due muri o con laterale fisso. Cristalli temperati sp.6mm e profili in alluminio. Regolazione dei profili a muro 4cm. La porta Sanderra si caratterizza per il minimalismo del sistema di scorrimento inferiore che garantisce una facile pulizia ed un Design essenziale.

Description

Sliding shower door for single installation between two walls, or to combine with a lateral fix side. 6mm safety glass and aluminum profiles. 4cms wall regulation profiles. The Sanderra shower door is characterized by the minimalism of the lower sliding system that guarantees easy cleaning and an essential design.

ART.	L. (cm)	H. (cm)	Cristallo Glass
SANDERRA DOOR	115/119	195	6mm trasparente
SANDERRA DOOR	120/124	195	6mm trasparente
SANDERRA DOOR	125/129	195	6mm trasparente
SANDERRA DOOR	130/134	195	6mm trasparente
SANDERRA DOOR	135/139	195	6mm trasparente
SANDERRA DOOR	140/144	195	6mm trasparente
SANDERRA DOOR	145/149	195	6mm trasparente
SANDERRA DOOR	150/154	195	6mm trasparente
SANDERRA DOOR	155/159	195	6mm trasparente
SANDERRA DOOR	160/164	195	6mm trasparente
SANDERRA DOOR	165/169	195	6mm trasparente
SANDERRA DOOR	170/175	195	6mm trasparente
SANDERRA DOOR	175/179	195	6mm trasparente

ART.	L. (cm)	H. (cm)	Cristallo Glass
SANDERRA FIX	65/70	195	6mm trasparente
SANDERRA FIX	75/80	195	6mm trasparente
SANDERRA FIX	85/90	195	6mm trasparente

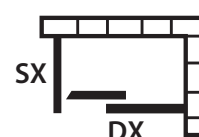
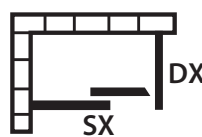
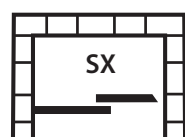
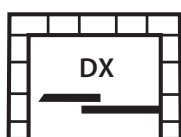

Versi di istallazione | installation sense

SANDERRA

Info tecniche

Profilo a muro (mm)

Wall profile

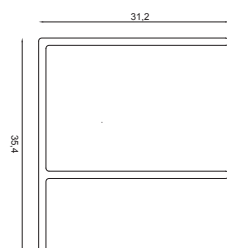

Alluminio



Argento satinato



Cromo





PLANAS COLLECTION

Box Doccia Scorrevole **PLANAS DOOR_FIX**

Descrizione

Porta doccia scorrevole per installazione tra due muri o con laterale fisso. Cristalli temperati sp.6mm e profili in alluminio. Regolazione dei profili a muro 4cm. A differenza della porta doccia Sanderra, la porta scorrevole PLANAS prevede un telaio uniforme planare, che incornicia il box doccia su tutti e 4 i lati.

Description

Sliding shower door for single installation between two walls, or to combine with a lateral fix side. 6mm safety glass and aluminum profiles. 4cms wall regulation profiles. Differently from the Sanderra shower door, the sliding door PLANAS the sliding door PLANAS provides a uniform planar frame, which frames the shower enclosure on all 4 sides.

ART.	L. (cm)	H. (cm)	Cristallo Glass
PLANAS DOOR	115/119	195	6mm trasparente
PLANAS DOOR	120/124	195	6mm trasparente
PLANAS DOOR	125/129	195	6mm trasparente
PLANAS DOOR	130/134	195	6mm trasparente
PLANAS DOOR	135/139	195	6mm trasparente
PLANAS DOOR	140/144	195	6mm trasparente
PLANAS DOOR	145/149	195	6mm trasparente
PLANAS DOOR	150/154	195	6mm trasparente
PLANAS DOOR	155/159	195	6mm trasparente
PLANAS DOOR	160/164	195	6mm trasparente
PLANAS DOOR	165/169	195	6mm trasparente
PLANAS DOOR	170/175	195	6mm trasparente
PLANAS DOOR	175/179	195	6mm trasparente

ART.	L. (cm)	H. (cm)	Cristallo Glass
PLANAS FIX	65/70	195	6mm trasparente
PLANAS FIX	75/80	195	6mm trasparente
PLANAS FIX	85/90	195	6mm trasparente

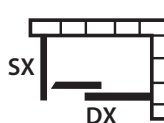
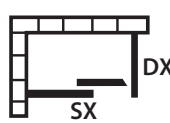
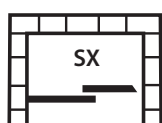
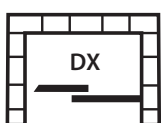

Versi di installazione | installation sense

PLANAS

Info tecniche

Profilo a muro (mm)

Wall profile

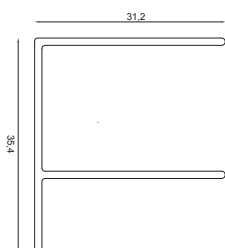

Alluminio



Argento satinato



Cromo





GENERAL SALES CONDITIONS

The following sales conditions are intended to be accepted by sending the order.

1. PRICELIST

The following price list cancels and replaces the previous ones, and can be changed at any time without notice. The prices shown are VAT excluded, including packaging, ex works, net of tax burdens, taxes, installation and other services always and total commitment of the customer.

2. ORDERS

Orders are subject to approval by the manufacturer. Any requests for changes will be accepted and made only if received within 2 days from the date of receipt of the same.

3. DELIVERIES AND PAYMENTS

The terms of delivery, referred to the date of receipt of orders, are purely indicative, therefore any delays do not lead to cancellation, nor delay in payment, nor the return of the material or request for compensation. The buyer is required to comply with the agreed conditions, any insolvency will result in the suspension of orders to be processed. The material remains the property of FERBOX SRL up to the payment of the same and the success of the securities. In case of non-payment, the house can request, upon simple request, the return.

4. COMPLAINTS AND RETURNS

The material travels at the risk and peril of the client. Any breakages or shortages must be advanced to the carrier and noted in the relevant transport document. We do not accept complaints of material forwarded later. Possible claims for manufacturing defects, such as abrasions, dents, breakages or scratches, are contestable within 8 days from receipt of the goods and especially if the product has not been totally or partially installed. Any returns of material must be previously authorized by FERBOX SRL. The returned material must be received intact and suitably packaged.

5. WARRANTY

The products are guaranteed for a period of 24 months, with the exception of cases of incorrect transportation and storage of the goods by the Customer, incorrect installation, bad use, poor maintenance and in the case of delay and insolvency, even partial of the purchaser.

6. JURISDICTION

For any dispute, the only jurisdiction is the court of Fermo.

CONDIZIONI GENERALI DI VENDITA

Le sottoscritte condizioni di vendita si intendono accettate con l'invio dell'ordine.

1. LISTINO

Il seguente listino annulla e sostituisce i precedenti, e può essere modificato in qualsiasi momento anche senza preavviso. I prezzi indicati si intendono iva esclusa, compresi di imballo, franco nostra fabbrica, al netto di oneri fiscali, imposte, installazione e di altra prestazione sempre e totale impegno del committente.

2. ORDINI

Gli ordini sono subordinati all'approvazione della casa madre. Eventuali richieste di modifiche verranno accettate e apportate solo se pervenute entro 2 giorni dalla data di ricezione degli stessi.

3. CONSEGNE e PAGAMENTI

I termini di consegna, riferiti alla data di ricezione degli ordini, sono puramente indicativi, pertanto eventuali ritardi non ne comportano l'annullamento, né il ritardo nel pagamento, né la restituzione del materiale o richiesta di risarcimento. L'acquirente è tenuto a rispettare le condizioni pattuite, eventuali insolvenze comporteranno la sospensione degli ordini da evadere. Il materiale rimane di proprietà della FERBOX SRL sino al pagamento dello stesso e al buon esito dei titoli. In caso di mancato pagamento, la casa può esigerne, dietro semplice richiesta, la restituzione.

4. RECLAMI E RESI

Il materiale viaggia a rischio e pericolo del committente. Eventuali rotture o ammanchi dovranno essere avanzati al vettore ed annotati nel relativo documento di trasporto. Non si accettano reclami di materiale inoltrati successivi. Eventuali reclami per difetti di fabbricazione, tipo abrasioni, ammaccature, rotture varie o graffi, sono contestabili entro 8 giorni dal ricevimento della merce e soprattutto se il prodotto non è stato totalmente o parzialmente installato. Eventuali resi di materiale dovranno essere preventivamente autorizzati dalla FERBOX SRL. Il materiale restituito dovrà pervenire integro ed idoneamente imballato.

5. GARANZIA

I prodotti sono garantiti per la durata di 24 mesi, ad eccezione dei casi di errato trasporto ed immagazzinamento della merce da parte del Cliente, errata installazione, cattivo uso, cattiva manutenzione e nel caso di more e insolvenze, anche parziali dell'acquirente.

6. FORO COMPETENTE

Per qualsiasi controversia, unico foro competente è il tribunale di Fermo.

FERBOX SRL

C.da Campiglione, 20
63900 Fermo (Fm) - Italia
Tel +39.0734.628919
Fax +39.0734.628718
info@ferbox.it
www.ferbox.it